

MONSTER POWER®



Home Theatre
Reference
PowerCenter™
HTS 3600 MKII

Owner's Manual

PowerCenter™
de référence
pour cinéma maison
HTS 3600 MKII

Guide de l'utilisateur

TABLE OF CONTENTS

	Page
Important Safety Information	i
Proper Grounding and Installation	iii
A Note from The Head Monster	1
Monster's Exclusive T2™ Technology	3
Monster's Patented Clean Power™ Stages	4
The Minds Behind The Monster PowerCenter™ Design.	5
Monster HTS 3600 MKII PowerCenter Features	6
Hook-Up Guide	10
Digital Outlets	10
Video Outlets	11
Analog Audio Outlets	12
High Current Audio Outlets	13
Coaxial Connections	14
Phone Connections	15
Remote "DC In" Control	16
Remote "AC In" Control	16
Remote "DC Out" Control	16
Rack Mounting	17
Troubleshooting	18
Specifications	22
Appendices	
Owner's Manual in French (Guide d'Utilisation en Français)	31

IMPORTANT SAFETY INFORMATION

Please read and observe the following safety points at all times.

WARNING – Power Sources

Do not plug this PowerCenter™ into a power outlet that differs from the source indicated for safe use on the PowerCenter. If you don't know the type of electrical power that is supplied to your home, consult your local power company or a qualified electrician.

WARNING – Grounding and Polarization

- A. Do not force your PowerCenter™ plug into an outlet that is not designed to accept a three-wire grounded-type AC plug (a three-prong plug). This plug is designed to be inserted into a grounded-type outlet only. If this plug doesn't fit directly inside your outlet, do not attempt to force it into the outlet. Never attempt to dismantle the plug in any way (or to alter the power cord). Do not attempt to defeat the grounding feature by using a 3-to-2 prong adapter. If you have questions about grounding, consult your local power company or a qualified electrician.
- B. If you use rooftop devices such as satellite dishes, antennas, or any other component with wire that connects to your PowerCenter™, be sure the wire(s) is properly grounded. This protects against voltage surges and static charges.
- C. Do not place any antenna near overhead power lines or any other power circuit. Do not touch any power line or power circuit. Doing so may cause severe physical injury or possibly death.

WARNING – Liquid: Avoiding Electrical Shocks

- A. Do not operate your Monster PowerCenter if liquid of any kind is spilled onto or inside the unit.
- B. Do not operate your Monster PowerCenter near rain or water that's spilled or contained (e.g., bathtub, kitchen or sink).

⚠️ WARNING – Power Cord Safety

- A. When routing your PowerCenter's AC power cord, do not place it near heavy foot traffic areas (e.g., hallways, doorways, and floors). Do not create a trip hazard with the power cord.
- B. If your power cord's protective jacket begins to rip or fray, exposing the internal wiring, shielding, etc., disconnect it from the power source and discontinue use of the Monster PowerCenter immediately. See the Warranty Information section of this owner's manual for important details.

⚠️ WARNING – Storm Precautions

In the event of a lightning storm, it's always a good idea to disconnect your Monster PowerCenter; there is no need to disconnect your separate components. Make sure that ALL of your components and PC products are protected with Monster Power.

⚠️ WARNING – No User Serviceable Parts Inside

If, for any reason, your PowerCenter is not operating properly, do not remove any part of the unit (cover, etc.) for repair. Unplug the unit and consult the Warranty Information section of this owner's manual for important details.

⚠️ CAUTION – Exposure To Heat

Do not expose your PowerCenter to direct sunlight or place it near wall heaters, space heaters, or any enclosed space prone to temperature increase.

⚠️ CAUTION – Proper Cleaning

In general, the only cleaning necessary for your Monster PowerCenter is a light dusting. Unplug your component from the wall before cleaning it. Do not use any type of liquid or aerosol cleaners.

PROPER GROUNDING AND INSTALLATION

WARNING – Proper Grounding

Monster PowerCenters require a properly grounded outlet for safety and to protect connected equipment. If you're not sure if your home's electrical wiring is properly grounded, have it checked by a qualified electrician.

Important Note – Proper Power and Protection

To completely protect your equipment against electrical surges, every AC power cable, coaxial cable and phone line in the system must be connected to an appropriate PowerCenter.

Important Note – Proper Protection and the Limited Connected Equipment Warranty

The \$500,000 Limited Connected Equipment Warranty becomes invalid if any wire (AC, coax or phone) or audio or video interconnect leading into the equipment comes from a component that is not properly protected by the PowerCenter. See the Warranty Information section of this owner's manual for important details.

A NOTE FROM THE HEAD MONSTER

Dear Enthusiast,

THANK YOU for purchasing the Monster Power Home Theatre Reference HTS 3600 MKII PowerCenter. This PowerCenter reflects our commitment to creating performance-enhancing solutions for home theater systems, so you can enjoy superior sound and picture quality.

As a long-time audiophile and serious home theater enthusiast, I always knew problematic AC power could degrade picture and sound quality. Unfortunately, ordinary AC power accessories can compromise the performance of the components they power. So, I decided to address the issue. And, with the help of Richard Marsh and other power experts, Monster Power was born. This PowerCenter's advanced technology and innovative design provides several unique performance and convenience features. Here are the highlights...

Monster PowerCenters do an excellent job of protecting your components from harmful power surges, but its benefits include much more than just surge protection. The patented Monster Clean Power™ filter circuitry virtually stops the electromagnetic and radio frequency noise that goes right through typical surge protectors which can degrade sound and picture quality. In addition, your PowerCenter also features patented noise isolation circuits that separate analog audio, video, digital and ultra-high current audio outlets. The result is high quality sound and picture that's free from performance-damaging interference.



Noel Lee

Other Monster Power breakthroughs include exclusive T2™ automatic disconnect protection circuitry and patented Tri-Mode™ protection (US 6,683,770 B1) featuring an audible alarm. These features automatically disconnect power from your electronics if you're hit by a big surge. We've also included surge-protected coax and phone connections to ensure protection for all of your components. Monster PowerCenters also feature a patent pending color-coding system, which identifies where each component should be connected.

These days, home theater components are better than ever, providing thrilling and dramatic sound and razor sharp picture. We know your new PowerCenter will help bring it all together with Clean Power and superior system protection. With Monster Power, you'll enjoy the best possible sound and picture. And, that's what home theater is all about.

A handwritten signature in black ink, appearing to read 'Noel Lee', with a stylized flourish at the end.

Noel Lee,
The Head Monster

MONSTER'S EXCLUSIVE T2™ TECHNOLOGY

The Monster Power HTS 3600 MKII PowerCenter features exclusive Monster T2 technology. T2 is an active electronic microprocessor-controlled circuit that sits in front of the surge protection circuitry in select Monster Power products. T2 monitors the line, neutral and ground lines and automatically disconnects the PowerCenter from the AC power line when a long duration low-voltage sag or high-voltage swell occurs (continuous voltage below 70Vrms or above 132Vrms).

When the voltage sags or swells to these potentially damaging levels, ultra-fast T2 auto-disconnect protection circuitry shuts down the Monster PowerCenter for 15 seconds. When the under-voltage or over-voltage condition returns to normal, T2 reconnects the PowerCenter to full operation after 15 seconds. If the fault condition does *not* clear, the T2 comparator circuit keeps the unit shut down.

Unlike ordinary power management devices, T2 will shut down your PowerCenter before the MOVs (Metal Oxide Varistors) and thermal fuses sense an overload condition and sacrifice themselves to protect your connected components. This will extend the PowerCenter's life, while providing the system protection you need.

MONSTER'S PATENTED CLEAN POWER™ STAGES

Monster Clean Power performs two tasks that are vital to maintaining optimum home theater performance: 1) noise filtration and 2) noise isolation. The higher the Clean Power stage number (1-5), the more sophisticated and advanced the filters are that reject noise generated on the AC powerline. In addition, the higher the Clean Power stage number, the more isolation that exists between connected equipment for maximum rejection of component-generated noise.

Monster PowerCenters featuring Clean Power circuitry are each designated with a Clean Power Stage. The HTS 3600 MKII incorporates Monster Clean Power **Stage 3** circuitry which filters both AC powerline noise and reduces noise generated by your connected equipment. Clean Power Stage 3 features three ultra-advanced, isolated filters that include analog audio, video and digital, plus an high current audio filter to provide for the best possible AC powerline noise rejection and inter-component isolation for improved component-generated noise rejection. All of these features make the HTS 3600 MKII ideal for your home theater system. To learn more about patented Monster Clean Power and the complete product family of PowerCenters, voltage stabilizers and amplifiers, please visit **MonsterPower.com**.

THE MINDS BEHIND THE MONSTER POWERCENTER DESIGN



Richard Marsh – There are few experts able to solve the complex problems associated with AC power and complex home theater systems. Richard Marsh is one of these illustrious few. He has designed best selling power conditioning components costing more than \$3,000 US and now brings his expertise to Monster Power. Richard developed Monster’s patented Clean Power™ circuitry which is incorporated into many of Monster’s PowerCenters. He is also responsible for several other groundbreaking designs. Richard’s background and research into amplifier and capacitor design led to his development of the Servo-DC feedback concept in power amplifiers – a concept that is used by virtually every amplifier manufacturer today. His status as both the inventor of the MultiCap™ internal bypass capacitor and as the driving force behind the high-end audio balanced circuit design concept has influenced the audiophile community for years. Richard is responsible for some of the high-end audio world’s most respected product designs, essays and articles, and has contributed to *The Absolute Sound* and *Audio* magazines. He is included in *Who’s Who in the West*.



Demian Martin – Demian Martin has been solving complex AC power problems for several years. As a technical consultant for successful paper and steel mills, Demian helped create several innovative AC power solutions. He developed techniques to dramatically improve the efficiency of these factories’ high power motor control systems – up to 50,000 watts — helping them avoid the costly premiums many factories must pay for AC power inefficiency. Demian was also the co-founder of Spectral Audio and was the chief designer of their many pioneering designs for amplifiers, D/A converters, and other high-end audio designs. He now brings his expertise to Monster Power’s elite research and development team.



Noel Lee – Noel Lee, The Head Monster, is best known for popularizing the concept of high performance audio cable 25 years ago with his creation of Monster Cable. Originally a laser-fusion design engineer at Lawrence Livermore National Laboratory and later a touring musician, Noel has invented or co-invented over 250 U.S. and international patents and drives the explosive growth of The Monster Group companies in more than 80 countries worldwide. Monster Power is Noel’s realization of a long-nurtured vision of making affordable power solutions that deliver the best possible sound and picture.

MONSTER HTS 3600 MKII POWERCENTER FEATURES

HTS 3600 MKII
FRONT VIEW

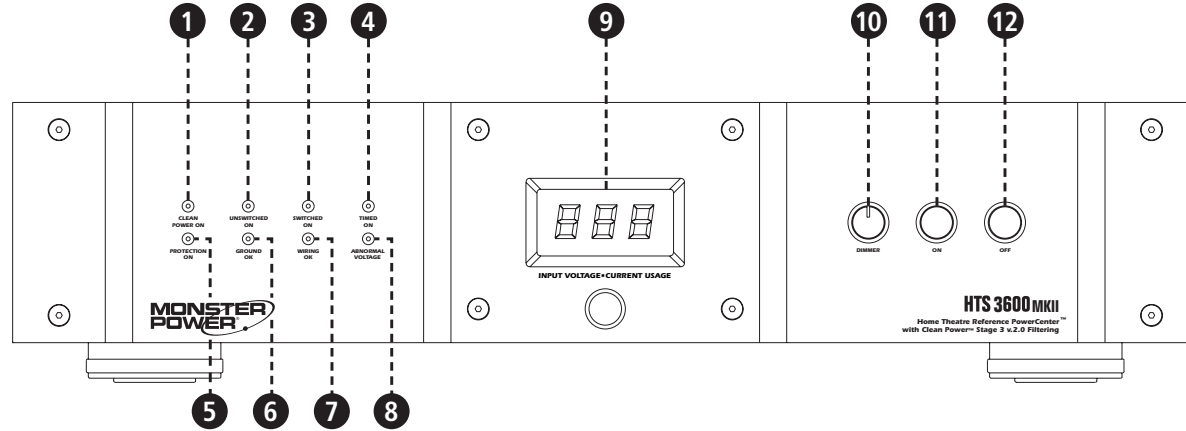

HTS 3600 MKII
REAR VIEW

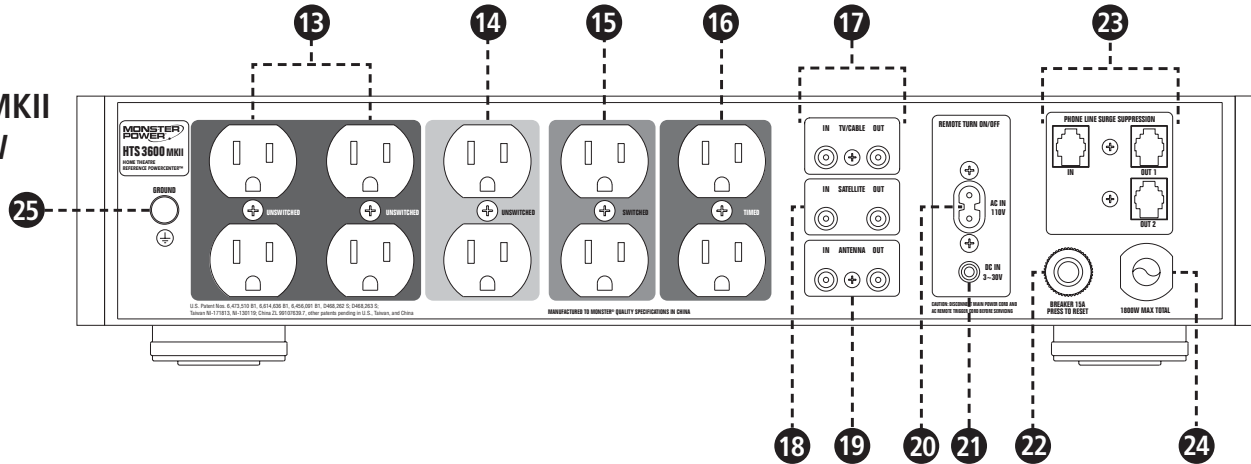

HTS 3600 MKII POWERCENTER FEATURES

1. **“Protection On” Indicator:** Indicates Monster surge protection circuitry is functioning properly.
2. **“Unswitched On” Indicator:** Indicates power is being supplied to the unswitched outlets.
3. **“Switched On” Indicator:** Indicates power is being supplied to the switched outlets.
4. **“Timed On” Indicator:** Indicates power is being supplied to outlets with the sequential turn-on feature.
5. **“Wiring OK” Indicator:** Indicates if the Line and Neutral wires from the wall outlet to the PowerCenter are reversed. Please consult your electrician to correct this immediately.
6. **“Ground OK” Indicator:** Indicates the PowerCenter is plugged into a properly grounded 120V AC outlet.
7. **“Clean Power On” Indicator:** Indicates Monster Clean Power circuitry is functioning properly.
8. **“Abnormal Voltage” Indicator:** Indicates that the incoming voltage is below approximately 70V AC or above approximately 130V AC.
9. **Digital Input Voltage and Current Usage Meter:** Indicates input voltage and amperage draw.
10. **Dimmer Knob:** Adjusts the brightness of the Digital Input Voltage and Current Usage Meter.
11. **“On” Button:** Turns on outlets programmed as “SWITCHED ON” or “SWITCHED ON AFTER DELAY”.
12. **“Off” Button:** Turns off outlets programmed as “SWITCHED ON” or “SWITCHED ON AFTER DELAY”.
13. **Digital Filter:** These outlets have a specifically designed filter circuit that reduces interference to your digital components.

- 14. Video Filter:** These outlets have a specifically designed filter circuit that reduces interference to your video components.
- 15. Analog Audio Filter:** These outlets have a specifically designed filter circuit that reduces interference to your audio components.
- 16. High Current Audio Filter (Switched/Timed Outlets):** These outlets have a specifically designed filter circuit for high power audio components like amplifiers and pre-amplifiers.
- 17. TV/Cable Protection:** Provides surge protection for a TV/cable connection. The input connects the coaxial cable from your antenna. The output connects the coaxial cable to your TV or cable box input.
- 18. Satellite Protection:** Provides surge protection for a satellite connection. The input connects the coaxial cable from your satellite dish. The output connects the coaxial cable to your satellite receiver input.
- 19. Antenna Protection:** Provides surge protection for an antenna connection. The input connects the coaxial cable from your radio antenna. The output connects the coaxial cable to your television.
- 20. Remote "AC In" Control:** Allows the PowerCenter to be automatically turned on by a remote AC trigger plugged into an outlet on another component, such as an AV receiver.
- 21. Remote "DC In" Control:** Allows you to automatically turn on the PowerCenter via the Remote "DC Out" on another component, such as an A/V receiver.
- 22. Resettable 15 Amp Circuit Breaker:** Protects the PowerCenter from continuous power overload.
- 23. Phone Line Surge Suppression:** Provides surge protection against damaging voltage surges and spikes from the phone line.

- 24. High Current PowerLine™ 200 AC Power Cable:** High density double shielded AC power cord specially designed to maximize power transfer.
- 25. Ground Terminal:** Provides a ground reference point for any ungrounded components.

HOOK-UP GUIDE

Digital Outlet Hook-Up

These outlets have a special filter circuit that is optimized to reduce interference to your digital components.

- A) Attach a Monster Power identification label to each component's power cord before you plug it into the appropriate color-coded PowerCenter outlet.
- B) Plug each component's power cord (Cable/SAT, DVD, etc.) into the PowerCenter's corresponding outlet. For components not listed, determine if they are audio, video, digital or high current audio components, and use a corresponding outlet for best performance.

IMPORTANT NOTE

It does not harm analog audio, video, or high current audio components to be connected to the digital outlets. However, for best performance, we recommend plugging in only digital components to the digital outlets.

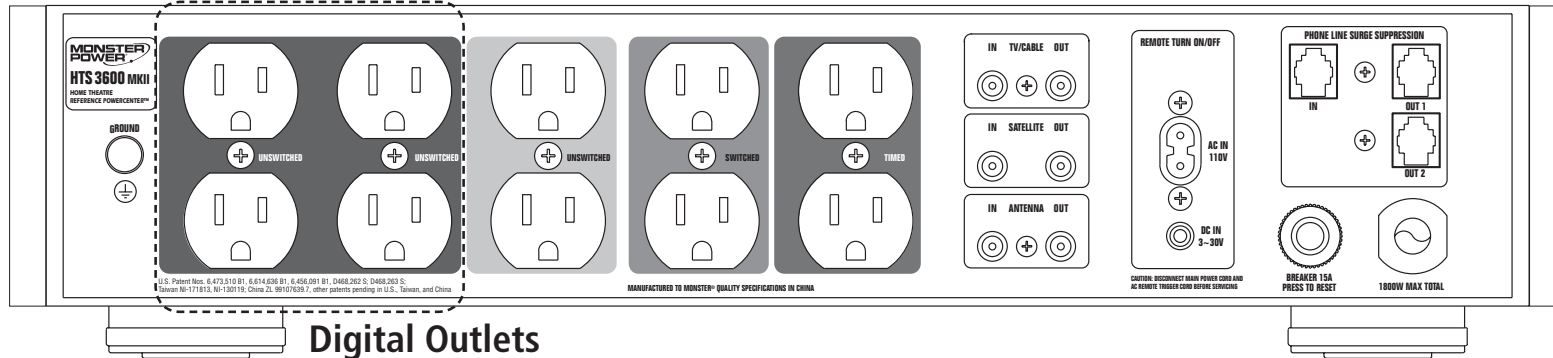

HOOK-UP GUIDE

Video Outlet Hook-Up

These outlets have a special filter circuit that is optimized to reduce interference to your video components.

- A) Attach a Monster Power identification label to each component's power cord before you plug it into the appropriate color-coded PowerCenter outlet.
- B) Plug each component's power cord (TV/Monitor, VCR) into the PowerCenter's corresponding outlet. For components not listed, determine if they are audio, video, digital or high current audio components, and use a corresponding outlet for best performance.

IMPORTANT NOTE

It does not harm analog audio, digital, or high current audio components to be connected to the video outlets. However, for best performance, we recommend plugging in only video components to the video outlets.

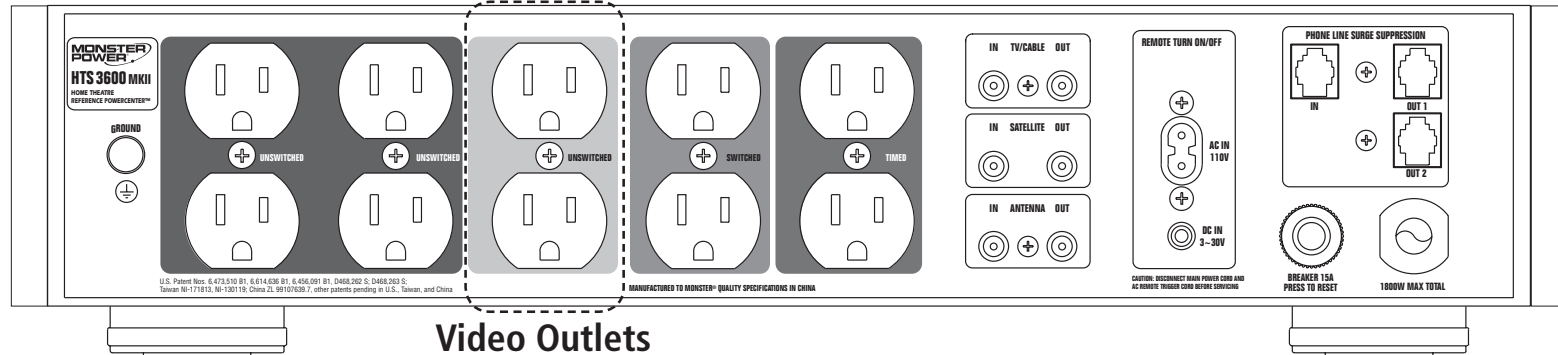

HOOK-UP GUIDE

Analog Audio Outlet Hook-Up

These outlets have a special filter circuit that is optimized to reduce interference to your audio components.

- A) Attach a Monster Power® identification label to each component's power cord before you plug it into the appropriate color-coded PowerCenter outlet.
- B) Plug each component's power cord (Receiver, Processor, etc.) into the PowerCenter's corresponding outlet. For components not listed, determine if they are audio, video, digital, or high current audio, and use a corresponding outlet for best performance.

IMPORTANT NOTE

It does not harm video, digital, or high current audio components to be connected to the analog audio outlets. However, for best performance, we recommend plugging in only analog audio components to the analog audio outlets.

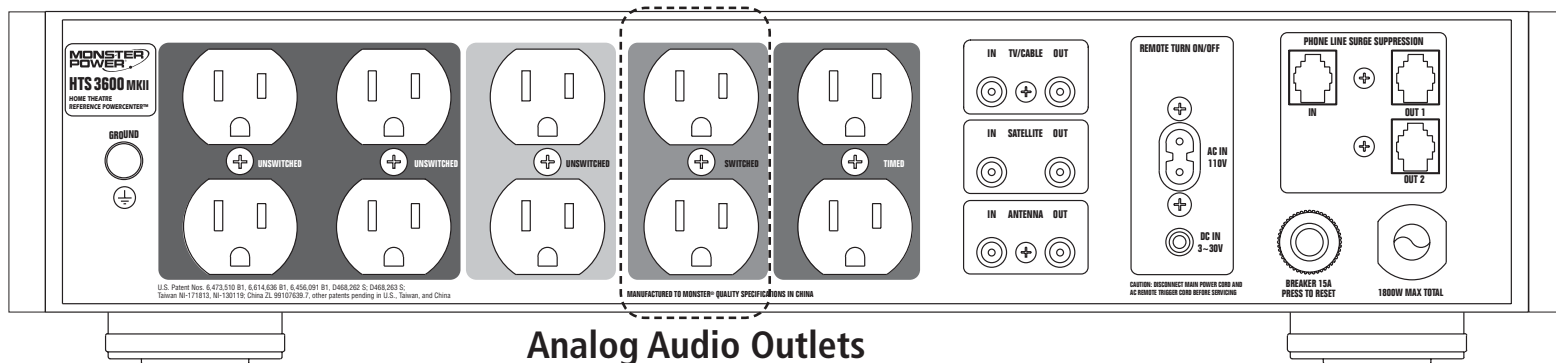

HOOK-UP GUIDE

High Current Audio Outlet Hook-Up

These outlets are designed to deliver maximum current to power hungry components like amplifiers and pre-amplifiers.

- A) Attach a Monster Power® identification label to each component's power cord before you plug it into the appropriate color-coded PowerCenter outlet.
- B) Plug each component's power cord (Amplifier, etc.) into the PowerCenter's corresponding outlet. For components not listed, determine if they are audio, video, digital, or high current audio, and use a corresponding outlet for best performance.

IMPORTANT NOTE

It does not harm analog audio, video, or digital components to be connected to the high current audio outlets. However, for best performance, we recommend plugging in only high-current audio components to the high current audio outlets.

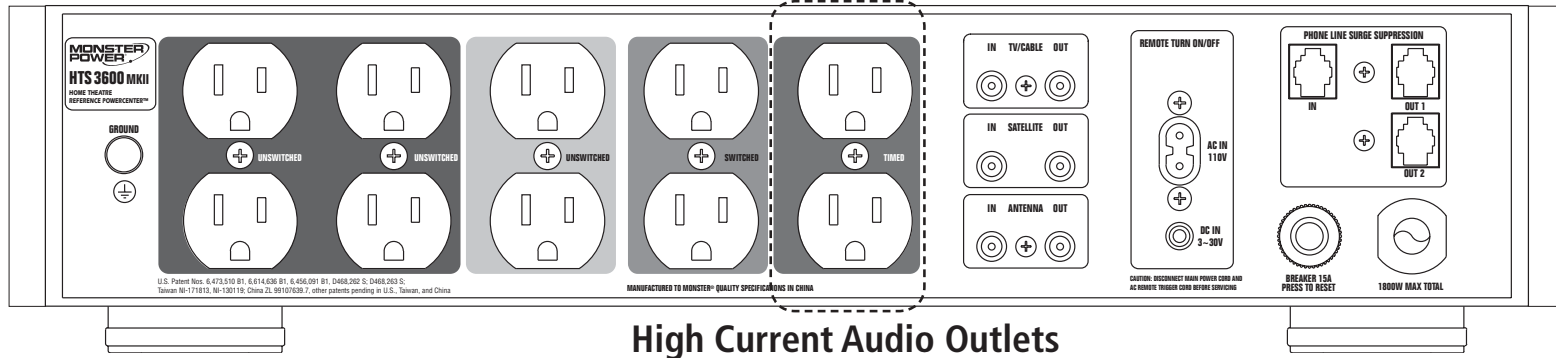

HOOK-UP GUIDE

Coaxial Connections Hook-Up

Coaxial Connections provide surge protection against damaging voltage surges and spikes on the incoming coax cable.

Protect TV/Cable, Satellite and Antenna Connections as Follows:

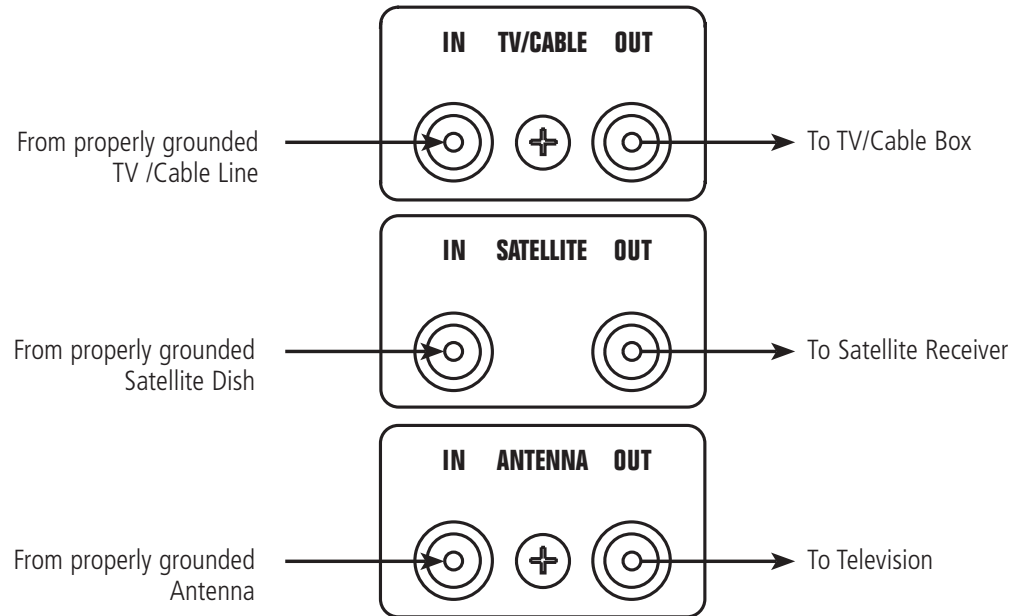

Note: You may need additional coaxial cables to connect the HTS 3600 MKII to your components.

HOOK-UP GUIDE

Phone Connections Hook-Up

Phone connections provide surge protection against damaging voltage surges and spikes coming from the phone line. This PowerCenter also incorporates a phone splitter for convenience.

Protect Phone Line Connections as Follows:

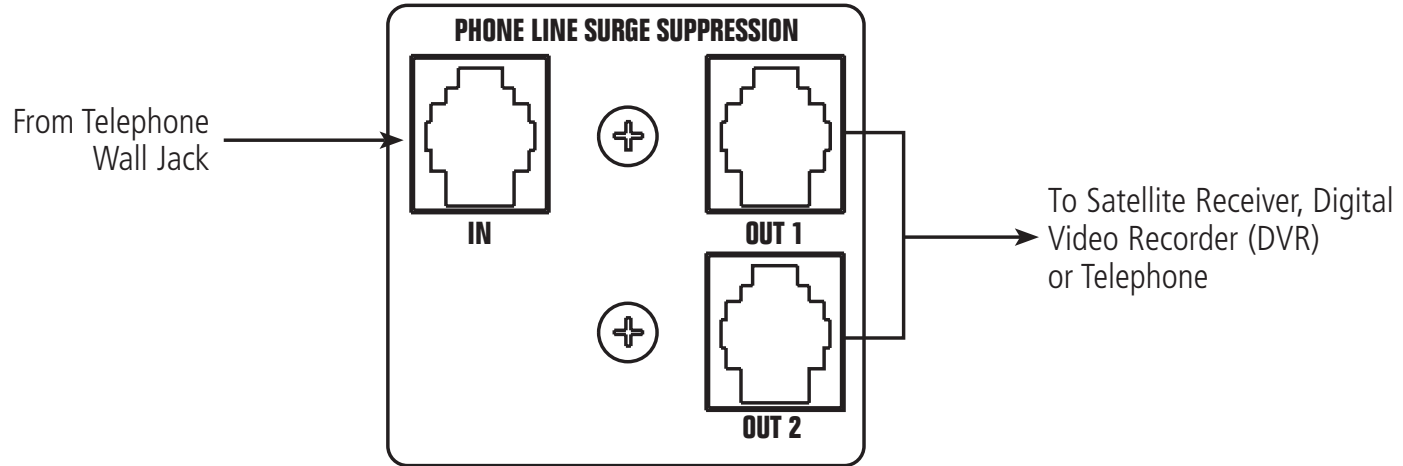

NOTE: The HTS3600 MKII is not intended for hook-up of any phone which carries two separate phone lines on a single 4-pin RJ11 jack.

HOOK-UP GUIDE

Remote "DC In" Control Hook-Up

This feature connects your PowerCenter to an automated Home Theater control system or allows another component with a Remote "DC Out" connection to automatically turn on and off your PowerCenter.

- A) Plug the AC power cable of the component you are using to control the PowerCenter into an unswitched outlet on the PowerCenter. Note: This component must deliver a control voltage between 3-30 volts DC.
- B) Plug one end of the 1/8" miniplug (supplied) into the corresponding Remote "DC In" connection on the PowerCenter.
- C) Plug the other end of the 1/8" miniplug into the Remote "DC Out" connection on the component that you want to turn on and off the PowerCenter's Switched Outlets when it is turned on.

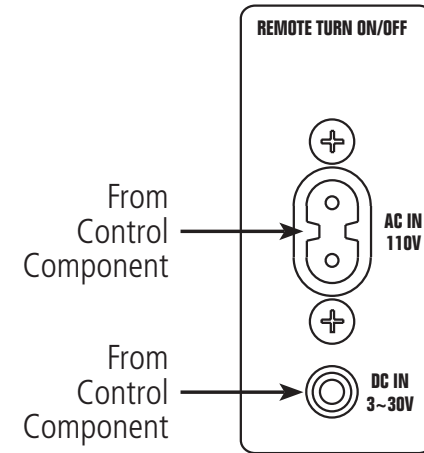

Remote "AC In" Control Hook-Up

This feature connects your PowerCenter to an automated Home Theater control system or allows another component with an AC outlet connection (for example, an AV receiver or preamplifier for example) to automatically turn on and off your PowerCenter.

- A) Insert the Remote "AC IN" Control cord's female plug into the "AC IN" 120V connection.
- B) Insert the Remote "AC IN" Control cord's 2-prong male plug into a switched AC power outlet on the component (AV receiver or preamplifier). When this device is turned on, the outlets programmed as "Switched On" on the PowerCenter will turn on immediately. The outlets programmed as "Switched On After Delay" will turn on after the set time delay.

HOOK-UP GUIDE

Rack Mounting Your PowerCenter

This Monster PowerCenter includes two "Rack Ears" mounting plates for installation into a standard size equipment rack.

- A)** Remove your PowerCenter trim covers using a $\frac{3}{32}$ or 2.5 mm Allen (Hex) key (not included). Turn each Allen screw counter-clockwise until the screw is completely removed.
- B)** Align one rack ear over the two holes on the left side of the PowerCenter. Using the Allen key, turn the two screws clockwise until tight. Repeat this step for the right side of the PowerCenter.
- C)** Place the PowerCenter into the rack and align the holes with the holes of your rack. Insert rack screws (not provided) and turn clockwise until tight.

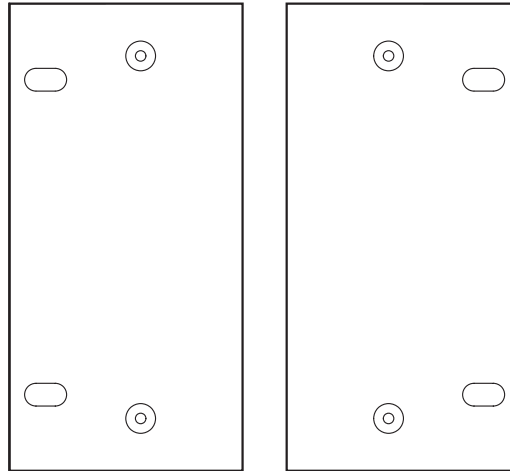

Rack Ears

TROUBLESHOOTING

Symptom	Possible Cause	Remedy
The PowerCenter is not receiving power.	The PowerCenter is not turned On.	<ul style="list-style-type: none">• Turn the PowerCenter switch on.• Make sure the PowerCenter's AC power plug is plugged into a properly grounded 120 volts (nominal) wall outlet.• In some households, a wall switch may need to be thrown to make the wall plug active. Try turning on the light switches located near the wall unit.
	Too many devices are connected, causing an overload, tripping the Thermal Circuit Breaker.	<ul style="list-style-type: none">• Press the PowerCenter Thermal Circuit Breaker button in to reset. Please allow 10 minutes before attempting to reset. If you reset too soon, the breaker will prematurely sense power overload and not allow unit to operate.• If the Circuit Breaker continues to trip, try moving one or more components to another PowerCenter. You may be drawing too much current through one PowerCenter.

TROUBLESHOOTING

Symptom	Possible Cause	Remedy
Component is not receiving power	The component is plugged into a switched outlet and the PowerCenter has not been turned On.	<ul style="list-style-type: none"> • Turn the PowerCenter On. • Or, plug the component into an Unswitched outlet.
	The PowerCenter is plugged into a Switched outlet, but power on the component is not On. In some instances, a component plugged into a switched outlet won't receive power when the PowerCenter is turned On unless the component power is also switched On.	<ul style="list-style-type: none"> • Turn the component power On.
Speakers emit a humming or buzzing noise	The PowerCenter is sharing AC power with equipment that is not properly grounded.	<ul style="list-style-type: none"> • Connect your PowerCenter to a dedicated outlet. • Try unplugging different components from the PowerCenter one at a time to see if the noise stops. If a component is discovered to be improperly grounded, attach a copper wire from the component's chassis to the PowerCenter's grounding post.

TROUBLESHOOTING

Symptom	Possible Cause	Remedy
The Unswitched LED on front panel is Off.	The PowerCenter is not plugged in.	<ul style="list-style-type: none"> • Plug the PowerCenter into a properly grounded 120 volts (nominal) outlet and make sure it is on.
	The PowerCenter is plugged in, but the outlet is not receiving power.	
The Switched LED is Off.	You are using the Switched Outlet Remote Turn-On feature and haven't plugged the plug into the component you wish to use to activate the Remote Turn-On.	<ul style="list-style-type: none"> • Plug the plug into the component you wish to use to activate the Remote Turn-On.
	The component remote control you are using to power the Remote turn-on has a dead battery.	<ul style="list-style-type: none"> • Replace the battery powering the component remote control. • Plug the component into a properly grounded 120 volt (nominal) outlet.
	The component you wish to use to activate the Remote Turn-On isn't plugged into a properly grounded 120 volt (nominal) outlet.	<ul style="list-style-type: none"> • Plug the PowerCenter into a properly grounded 120 volts (nominal) outlet.

TROUBLESHOOTING

Symptom	Possible Cause	Remedy
<p>“Timed On” indicator on front panel is Off.</p>	<p>You are using the Remote Turn-On feature (Same as Switched) and haven’t plugged the plug into the component you wish to use to activate the Remote Turn-On.</p>	<ul style="list-style-type: none"> • Plug the plug into component you wish to use to activate the Remote Turn-On.
	<p>The component remote control you are using to power the Remote turn-on has a dead battery.</p>	<ul style="list-style-type: none"> • Replace the battery powering the component remote control.
	<p>The component you wish to use to activate the Remote Turn-On isn’t plugged into a properly grounded 120 volt (nominal) outlet.</p>	<ul style="list-style-type: none"> • Plug the component into a properly grounded 120 volt (nominal) outlet.
<p>Video picture has rolling bars or ghosting.</p>	<p>The incoming video signal is not properly grounded.</p>	<ul style="list-style-type: none"> • Contact your cable or satellite provider to correct your installation.
<p>The PowerCenter is emitting a loud buzzing alarm.</p>	<p>The PowerCenter protection circuitry has sacrificed itself to protect connected equipment from a catastrophic surge.</p>	<ul style="list-style-type: none"> • The PowerCenter must be replaced. See the Warranty Information section for important details.

SPECIFICATIONS

HTS 3600 MKII POWERCENTER

Continuous Duty Electrical Rating	120V/60Hz	
Maximum Current Rating	15A/1800W	
Protection Modes	Line-Neutral (L-N) Line-Ground (L-G) Neutral-Ground (N-G)	
Total Energy Dissipation	6500 Joules	
Clamping Level (TVSS Voltage)	330 Volts	
Clamping Response Time	Less than 1 Nanosecond (<1Ns)	
Remote "DC In" Control	3 – 30V DC	
Remote "DC Out" Control	12V DC 100mA	
Dimensions	Width:	17" 434.0mm
	Height with Feet:	5.275" 134.0mm
	Height without Feet:	5.9" 150.0mm
	Depth:	14.42" 366.5mm

LIMITED WARRANTY FOR CONSUMERS

Monster, LLC, 7251 West Lake Mead Blvd, Las Vegas, NV, USA (“Monster”) extends You this Limited Warranty. Statutory or common law may provide You with additional rights or remedies, which shall not be affected by this Limited Warranty.

DEFINITIONS

“Adequate Use” means use of the Product and Connected Equipment (i) within a home or dwelling, (ii) for private (as opposed to commercial) purposes, (iii) in conformance with all applicable local, state or federal law, code or regulations (including without limitation building and/or electrical codes), (iv) in accordance with manufacturer recommendations and/or instructions in the materials and documentation that accompany the Product and any Connected Equipment, (v) with proper electrical grounding, (vi) with proper and direct connection between the Product and an AC power source that has protective grounding (excluding gas or diesel powered generators), (vii) with cable or telephone lines to any Connected Equipment properly connected to the Product, and (viii) without a connection in a “daisy-chain” fashion to or with any extension cord, surge suppressor, power strip, uninterruptible power supply (“UPS”) or other equipment.

“Authorized Dealer” means any distributor, reseller or retailer that (i) was duly authorized to do business in the jurisdiction where it sold the Product to You, (ii) was permitted to sell You the Product under the laws of the jurisdiction where You bought the Product, and (iii) sold You the Product new and in its original packaging.

“Connected Equipment” means any device that is (i) generally suited to be used with the Product or products of the same kind, (ii) meets the requirements of all applicable laws and safety standards, (iii) contains only parts manufactured, sold or recommended by the original manufacturer of the Connected Equipment, and (iv) has not been altered, tampered with or modified by any person other than its manufacturer or service personnel authorized or recommended by the manufacturer of the Connected Equipment.

“Connected Equipment Damage” means physical damage caused to Connected Equipment due to a Product Defect (i) by a transient AC power, cable, telephone, or lightning surge while connected to a properly installed Product, (ii) not

by a defect or unrelated damaging of the Connected Equipment or a surge/spike or lightning strike through a source, medium or connection other than through the Product, and (iii) does not extend to loss of data or consequential, indirect or special damages resulting from the Connected Equipment Damage.

“Fair Market Value” (“FMV”) means the fair market value of the Connected Equipment at the time Connected Equipment Damage occurs.

“Formal Warranty Claim” means a claim made in accordance with the section “Formal Warranty Claims” herein.

“Maximum Coverage Amount” means the maximum amount that Monster will pay to You under this Limited Warranty for Connected Equipment Damages and is defined in relation to each Product in the Specifications Table below.

“Product” means a Product (i) that is listed in the Specifications Table below, (ii) that You bought from an Authorized Dealer new and in its original packaging, and (iii) whose serial number, if any, has not been removed, altered, or defaced.

“Product Defect” means an inadequacy of the Product that existed at the time when You received the Product from an Authorized Dealer and that causes a failure of the Product to perform in accordance with Monster’s documentation accompanying the Product, unless such failure has been caused completely or partly by (a) any use other than Adequate Use, (b) transportation, neglect, misuse or abuse by anyone other than Monster’s employees; (c) alteration, tampering or modification of the product by anyone other than a Monster employee; (d) accident (other than a malfunction that would otherwise qualify as a Product Defect); (e) maintenance or service of the Product by anyone other than a Monster employee; (f) exposure of the Product to heat, bright light, sun, liquids, sand or other contaminants; or (g) acts outside the control of Monster, including without limitation acts of God, fire, storms (excluding lightning surges), earthquake or flood.

“Warranty Period” means the time period during which Monster must have received Your Formal Warranty Claim. The different Warranty Periods related to Product Defects and Connected Equipment Damage are defined in the Specifications Table below. The Warranty Period commences on the date when You purchased or received (whichever occurs later) the Product from an Authorized Dealer as evidenced by the Authorized Dealer’s invoice, sales receipt or packing slip. If You do not have written proof of the date of purchase or receipt, then the Warranty Period commences three (3) months

after the date when the Product left Monster's or its factory as evidenced by Monster's records. The Warranty Period ends after the time defined in the Specifications Table has expired, or after You have transferred ownership of the Product, whichever occurs earlier. Also, You must call Monster and obtain a Return Authorization Number (as described under "How to Make a Claim") within two (2) months after You discover a Product Defect (or should have discovered it, if such Product Defect was obvious).

"You" means the first individual person that purchased the Product in its original packaging from an Authorized Dealer. This Limited Warranty does not apply to persons or entities that bought the Product (i) in used or unpackaged form, (ii) for resale, lease or other commercial use, or (iii) from someone other than an Authorized Dealer.

SCOPE OF THIS LIMITED WARRANTY

PRODUCTS. If a Product contained a Product Defect when You bought it from an Authorized Dealer and Monster receives a Formal Warranty Claim from You within two (2) months after You discover such Product Defect (or should have discovered it, if such Product Defect was obvious) and before the end of the Warranty Period for Product Defects applicable to the affected Product, then Monster will provide You with one of the following remedies: Monster will (1) repair or, at Monster's sole discretion, replace the Product, or (2) refund to You the purchase price You paid to the Authorized Dealer for the affected Product if repair or replacement is not commercially practicable or cannot be timely made.

CONNECTED EQUIPMENT DAMAGE. Monster will also provide You with a remedy regarding Connected Equipment Damage if (i) You have a claim under the Limited Warranty for Products because of a Product Defect that causes Connected Equipment Damage despite Adequate Use, and (ii) Monster receives a Formal Warranty Claim from You before the end of the Warranty Period for Connected Equipment Damage applicable to the affected Product. If the conditions listed in the preceding sentence are met, Monster will provide You with one of the following remedies provided that Monster may decide at its sole discretion which of the three remedies it provides: Monster will (1) replace the damaged Connected Equipment; (2) pay to repair the damaged Connected Equipment; or (3) pay You the FMV of the Connected Equipment, provided that such payments shall not exceed (i) the Maximum Coverage Amount for the Product, or (ii) the actual damage having arisen from power surges due to a Product Defect. NOTE: COMPENSATION FOR RESTORATION OF DATA LOSS IS NOT COVERED AND MONSTER DOES NOT ASSUME ANY LIABILITY FOR ANY INCIDENTAL, CONSEQUENTIAL OR INDIRECT DAMAGES UNDER THIS LIMITED WARRANTY.

GENERAL PROVISIONS

CHOICE OF LAW/JURISDICTION. This Limited Warranty and any disputes arising out of or in connection with this Limited Warranty (“Disputes”) shall be governed by the laws of the State of California, USA, excluding conflicts of law principles and excluding the Convention for the International Sale of Goods. The courts located in the State of California, USA shall have exclusive jurisdiction over any Disputes.

OTHER RIGHTS. THIS LIMITED WARRANTY GIVES YOU SPECIFIC LEGAL RIGHTS, AND YOU MAY ALSO HAVE OTHER RIGHTS, WHICH VARY FROM STATE TO STATE AND JURISDICTION TO JURISDICTION, AND WHICH SHALL NOT BE AFFECTED BY THIS LIMITED WARRANTY. THIS WARRANTY EXTENDS ONLY TO YOU AND CANNOT BE TRANSFERRED OR ASSIGNED. If any provision of this Limited Warranty is unlawful, void or unenforceable, that provision shall be deemed severable and shall not affect any remaining provisions. In case of any inconsistency between the English and other versions of this Limited Warranty, the English version shall prevail.

REGISTRATION. Please register Your Product at **MonsterCable.com**. Failure to register will not diminish Your warranty rights.

SPECIFICATIONS TABLE

*"Lifetime" means the lifetime of the original individual purchaser of the Product, or for as long as the original individual purchaser owns the Product, whichever is less in time.

Product Model No.	Warranty Period for Products	Maximum Coverage Amount	Warranty Period for Connected Equipment Damage
HTS 3600 MKII	5 Years	\$500,000	5 Years

FORMAL WARRANTY CLAIM

HOW TO MAKE A CLAIM. In the event damage has occurred to Products, You must follow these instructions:

(1) Call Monster within two (2) months after You discover a Product Defect (or should have discovered it, if such Product Defect was obvious); (2) Give a detailed explanation of how the damage occurred; (3) Obtain a Return Authorization Number; (4) Upon receipt of a claim form (which may be sent to You after You filed Your Formal Warranty Claim), fill out the claim form entirely; (5) Return the Products, shipping prepaid by You (to be refunded if You are entitled to a remedy under the Scope of this Limited Warranty), to Monster for verification of damage, along with a copy of Your original sales receipts and proof of purchase (UPC label or packing slip) for such Products, the completed claim form, and printed Return Authorization Number on the outside of the return package (the claim form will include instructions for return).

FURTHER PROCEEDINGS. Monster will determine whether a Product Defect existed. Monster may, at its discretion, direct You to obtain a repair estimate at a service center. If a repair estimate is required, You will be instructed on how to properly submit the estimate and the resulting invoice to Monster for payment. Any fees for repairs may be negotiated by Monster.

TIMING. If You bring a Formal Warranty Claim and fully comply with all terms and conditions of this Limited Warranty, Monster will use its best efforts to provide You with a remedy within thirty (30) days after receipt of Your Formal Warranty Claim (if You reside in the United States – forty-five (45) days if You reside elsewhere), unless obstacles outside Monster's control delay the process.

Ver.121703 – US/EU ©2004 Monster, LLC.



Monster, LLC
7251 West Lake Mead Blvd.
Las Vegas, NV 89128 • USA

Visit us on the web at: MonsterPower.com.

Call us toll-free in North America at 877-800-8989.

The Monster Power Professional Reference
PowerCenter HTS 3600 MKII is protected under
U.S. Pat. No. 5,589,718. Other Patents Pending.

Designed in the USA by the Monster Power Dream Team
and manufactured to Monster quality specifications in China.

"Monster" "Monster Cable" "Monster Power"
"Clean Power" "PowerCenter" "PowerLine" "T2"
and "Tri-Mode" are registered and unregistered
trademarks of Monster Cable Products, Inc. and its
subsidiaries in the US and other locations.

© 2004 Monster, LLC.

Monster, LLC

Monster Technology International Limited
Ballymaley Business Park • Gort Road, Ennis, Co. Clare, Ireland

Visitez notre site à l'adresse : MonsterPower.com

Appelez-nous sans frais au : 1-866-348-4171

Le PowerCenter professionnel de référence
Monster Power HTS 3600 MKII est protégé par le brevet
U.S. N° 5,589,718. Autres brevets en instance.

Conçu aux É.-U. par The Monster Dream Team
et fabriqué selon les normes de qualité Monster en Chine.

« Monster », « Monster Cable », « Monster Power »,
« Clean Power », « PowerCenter », « PowerLine », « T2 »
et « Tri-Mode » sont des marques déposées et des marques
de commerce de Monster Cable Products, Inc. et de ses
filiales aux États-Unis et dans d'autres pays.

©2004 Monster, LLC.